

# Liko™ M220 / Liko™ M230



## Mobile lifts

### Instructions for Use

Liko M220      Prod. No. 2050010

Liko M230      Prod. No. 2050015

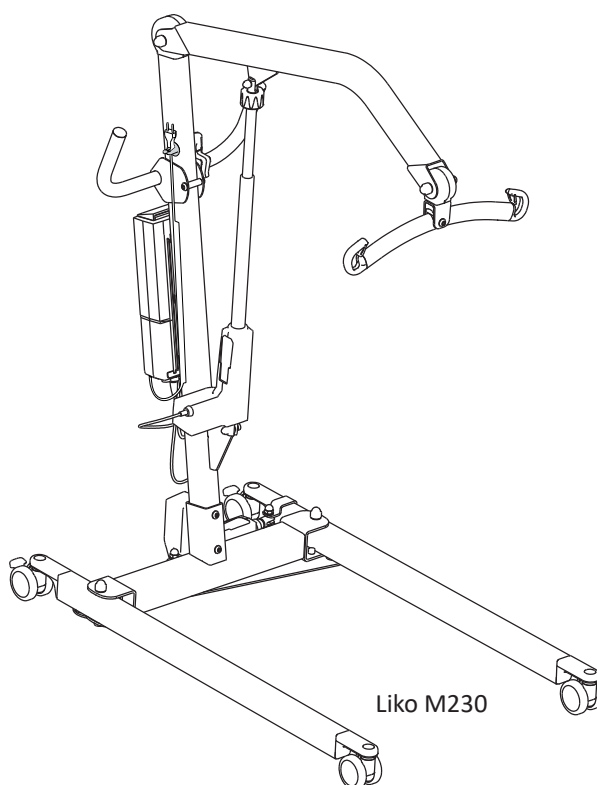

### Product Description

Liko M220 and M230 mobile lifts are easy-to-use mobile lifts primarily intended for use in nursing homes. Both models are excellent aids for daily transfers of adults and children; for instance, for transfers to and from a wheelchair, toilet and floor.

The models differ in the way the base width is adjusted while both lifts feature an electric lift mechanism. Liko M230 mobile lift has an electric base and Liko M220 mobile lift a manual base for opening and closing the legs.

An individually fitted sling and other accessories are of utmost significance for performance and safety when using Liko's lifts.

*In this document, the person being lifted is referred to as the patient, and the person helping them is referred to as the caregiver.*

#### **IMPORTANT!**





















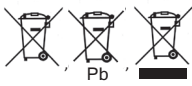



Lifting and transferring a patient always involves a certain level of risk. Read the instructions for use for both the patient lift and lifting accessories before use. It is important to completely understand the contents of the instructions for use. The equipment should only be used by trained personnel. Ensure that the lifting accessories are suitable for the lift used. Exercise care and caution during use. As a caregiver, you are always responsible for the patient's safety. You must be aware of the patient's ability to make it through the lifting situation. If something is unclear, contact the manufacturer or supplier.

# Table of Contents

Symbol Description .....	3
Safety Instructions .....	4
Definitions .....	5
Technical Data .....	5
Dimensions.....	6
EMC Table.....	6
Assembly .....	9
Operation .....	11
Charging the Batteries .....	13
Maximum Load.....	14
Recommended Lifting Accessories .....	14
Optional Components for Use with Lift.....	15
Troubleshooting .....	16
Recycling Instructions.....	17
Cleaning and Disinfection .....	18
Inspection and Maintenance .....	20

## Symbol Description

These symbols can be found in this document and/or on the product.

Symbol	Description
	For indoor use only.
	The product has extra protection against electric shock (Insulation Class II).
	Protection level against electric shock Type B.
	Warning; this situation requires extra care and attention.
	Read instructions for use before use.
	CE-mark.
IP N <sub>1</sub> N <sub>2</sub>	Protection level against: ingress of solid objects (N1) and ingress of water (N2).
	Legal Manufacturer.
	Date of manufacture.
	Caution! consult instructions for use.
	Read instructions for use before use.
	Battery.
	All batteries in this product must be recycled separately. - Pb underneath the symbol indicate batteries containing lead - Single Black line underneath the symbol indicate this product have been placed on the market after 2005.
	UL Recognized Component Mark for Canada and the United States.
	EFUP, Environmental Friendly Usage Period (years).
	Environmentally-friendly product which can be recycled and reused.
	The Australian Safety/EMC.
	PSE Mark (Japan).
	Product Identifier.
	Serial Number.
	Medical Device.
	Recyclable.
	The safety and essential performance of medical electrical equipment.
	Proof of Product compliance to North American safety standards.
	Non-ionizing electromagnetic radiation.
	Duty cycle for non-continuous operation. The maximum active operation time X% of any given time unit, followed by a deactivation time, Y%. The active operation time shall not exceed the specified time in minutes, T.
 <small>(01) 0100887761997127 (11) YYMMDD (21) 012345678910</small>	GS1 Data Matrix Barcode that may contain following information (01) Global Trade Item Number (11) Production Date (21) Serial Number

# Safety Instructions

## Intended use

This product is not intended to be used by the patient alone. Lifting and transferring a patient shall always be performed with the assistance of at least one caregiver. This product is used as a means to perform the lift but is not in contact with the patient; therefore we do not go into the various patient conditions in this manual. Contact your Hill-Rom representative for support and advice.

### **Certain environments and conditions can limit the correct use of the mobile lifts, including:**

Thresholds, unlevel floor surfaces, various obstacles, and extra-thick carpets. These environments and conditions can cause the wheels of the mobile lift not to roll as intended, possible imbalance in the mobile lift, and increased exertion by the caregiver. If you are uncertain that your care environment fulfils the requirements for correct use of the mobile lift, please contact your Hill-Rom representative for further advice and assistance.

Use the handles to maneuver the lift. Do not apply force to the lift arm or directly to the lift mast to maneuver; this may cause a tilting hazard.

### **Unbalanced lifting poses a tipping risk and may damage the lift equipment!**

### **Never leave a patient unattended during a lifting situation!**

#### Before use, make sure that:

- the lift is assembled in accordance with the assembly instructions;
- the lifting accessory are properly attached to the lift;
- the battery has been charged for at least 6 hours;
- you have read the instruction for use for the lift and lifting accessories;
- personnel using the lift are informed of the correct operation and use of the lift.

#### Before lifting, always make sure that:

- the lifting accessories are not damaged;
- the lifting accessory is correctly attached to the lift;
- the lifting accessory hangs vertically and can move freely;
- the lifting accessory is selected appropriately, in terms of type, size, material and design, with regard to the patient's needs;
- the lifting accessory is correctly and safely applied to the patient in order to prevent injuries;
- the sling bar latches are intact. Missing or damaged latches must always be replaced;
- the sling's strap loops are correctly connected to the sling bar hooks when the sling straps are stretched up but before the patient is lifted from the underlying surface.



### **No modification of the product is allowed.**

### **Use of the product adjacent to other equipment should be avoided because it could result in improper operation, if such use is necessary, observe and verify that the other equipment is operating normally.**

Electromagnetic disturbance, may affect the lifting performance of the product. Modification using other parts than original spare parts (cables etc.) may affect the electromagnetic compatibility of the product. Particular care must be observed when using strong sources of potential disturbance, such as diathermy, etc, so that diathermy cables are not positioned on or near the product.

If you have questions, please consult the responsible assistive device technician or the supplier.

The product may not be used in areas where flammable mixtures may occur, for example, in areas where flammable goods are stored.

This Caution notice is found on the Battery:

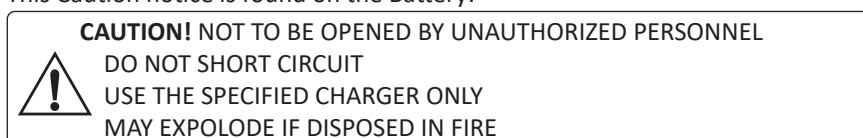

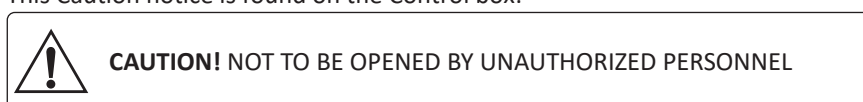

This Caution notice is found on the Control box:

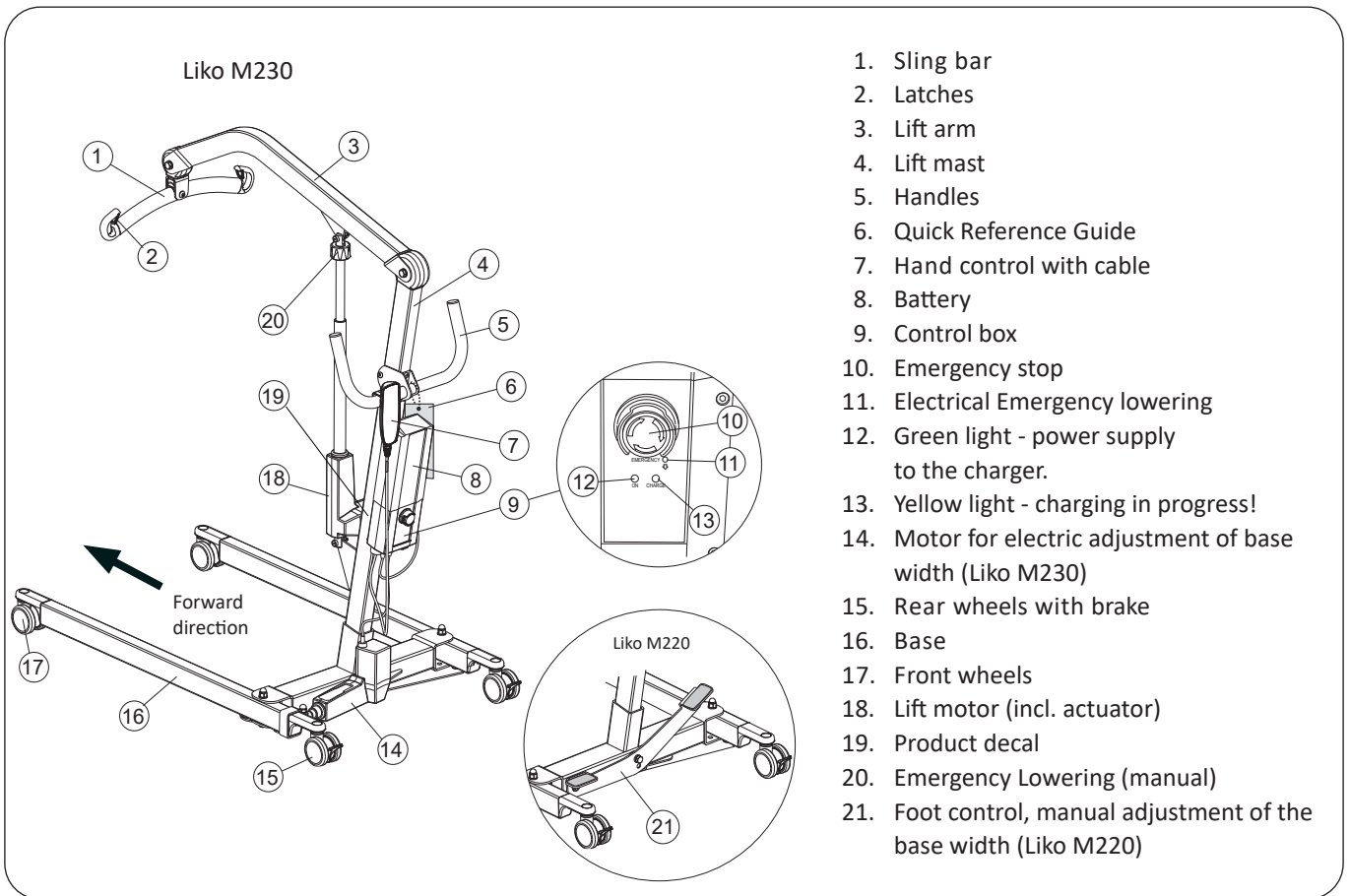

## Definitions



## Technical Data

<b>Maximum load:</b>	182 kg (400 lbs.)	<b>Intermittent power:</b>	Int. Op 10/90, active operation max 2 min. Only 10% of a given length of time may be active, but no more than 2 min.
<b>Material:</b>	Steel	<b>Battery:</b>	In series: 2 x 12 V 2.9 Ah valve-regulated lead-acid gel batteries. New batteries provided by the supplier.
<b>Weight:</b>	Gross: (Liko M220) 40 kg ( 88 lbs) (Liko M230) 40 kg ( 88 lbs)  Heaviest removable part: (Liko M220) 21 kg ( 46 lbs) (Liko M230) 21 kg ( 46 lbs)	<b>Battery charger:</b>	Built-in, 100-240 V AC, 50-60 Hz, max 400 mA.
<b>Wheels:</b>	Front: 75 mm (3 inch.) twin wheels Rear: 75 mm (3 inch.) twin wheels with brakes	<b>Lift motor:</b>	24 V DC, permanent magnetic motor with mechanical safety mechanism.
<b>Turning diameter</b>	1315 mm (52 inch.)	<b>Motor for base-width adjustment:</b>	24 V DC, permanent magnetic motor.
<b>Emergency lowering:</b>	Mechanical and Electrical	<b>Surrounding functional environment:</b>	Temperature: +10 to +40 °C (50 °F to 104 °F) without reduced performance. Humidity: 10% - 95% non-condensing, without reduced performance. Atmospheric pressure: 700 - 1060 hPa without reduced performance.
<b>Lifting interval:</b>	1155 mm (45.5 inch.)		
<b>Lifting speed (no load):</b>	18 mm/s (0.7 inch./s)		
<b>Sound level:</b>	42 dB(A)		
<b>Protection class:</b>	IP X4		
<b>Operating forces of controls:</b>	Buttons on hand control: 4N		The device is intended for use indoors.
<b>Electrical data:</b>	24 V		Type B, in accordance with the electrical shock protection class.
			Class II equipment.

## Dimensions

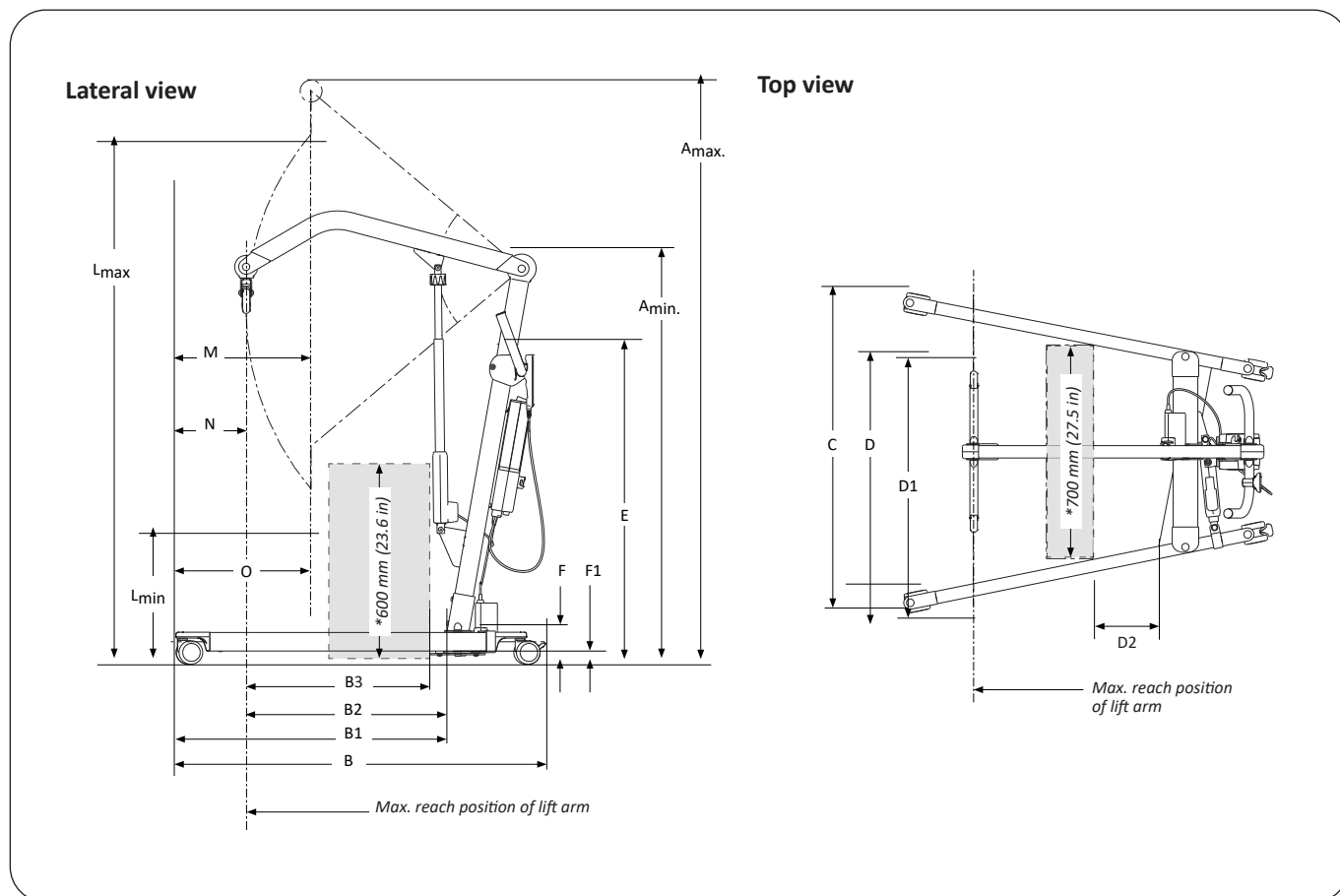

**Table of measurements**

(mm)

A <sub>max</sub>	A <sub>min</sub>	B	B1	B2*	B3	C		D		D1	*D2	E	F	F1	L <sub>max</sub>	L <sub>min</sub>	M	N	O
						max	min	max	min										
1900	1335	1215	890	645	615	1030	670	935	565	855	280	1070	105	25	1725	570	470	250	460

(inch.)

A <sub>max</sub>	A <sub>min</sub>	B	B1	B2*	B3	C		D		D1	*D2	E	F	F1	L <sub>max</sub>	L <sub>min</sub>	M	N	O
						max.	min.	max.	min.										
74.8	52.6	47.8	35.0	25.4	24.2	40.6	26.4	36.8	22.2	33.7	11.0	42.1	4.1	1.0	67.9	22.4	18.5	9.8	18.1

Note: When changing to other lifting accessories check that the lift still achieves desired lifting height.

\* Reference measurement according to Standard EN ISO 10535:2006

## EMC Table

<b>Guidance and manufacturer's declaration – electromagnetic emissions</b>		
The mobile lift is intended for use in the electromagnetic environment specified below. The customer or the user of the mobile lift should assure that they are used in such an environment. "Essential performance according to the manufacturer: The hoist shall not move unintentionally while being submitted to disturbances."		
Emissions test	Compliance	Electromagnetic environment - guidance
RF emissions CISPR 11	Group 1	The mobile lift uses RF energy only for its internal function. Therefore, its RF emissions are very low and are not likely to cause any interference in nearby electronic equipment.
RF emissions CISPR 11	Class B	The mobile lift is suitable for use in all establishments including domestic establishments and those directly connected to the public low-voltage power supply network that supplies buildings used for domestic purposes.
Harmonic emissions IEC 61000-3-2	Complies	
Voltage fluctuations/ flicker emissions IEC 61000-3-3	Complies	

## Guidance and manufacturer's declaration – electromagnetic immunity

The mobile lift is intended for use in the electromagnetic environment specified below. The customer or the user of the mobile lift should assure that it is used in such an environment.

"Essential performance according to the manufacturer: The mobile lift shall not move unintentionally while being submitted to disturbances."

Immunity test	IEC 60601 test level	Compliance level	Electromagnetic environment - guidance
Electrostatic discharge (ESD) IEC 61000-4-2	+/- 8 kV contact +/- 15 kV air	+/- 8 kV contact +/- 15 kV air	Floors should be wood, concrete or ceramic tile. If floors are covered with synthetic material, the relative humidity should be at least 30 %.
Electrical fast transient / Burst IEC 61000-4-4	+/- 2 kV for power supply lines +/- 1 kV for input/output lines	+/- 2 kV for power supply lines +/- 1 kV for input/output lines	Mains power quality should be that of a typical commercial or hospital environment.
Surge IEC 61000-4-5	+/- 1 kV Line to Line	+/- 1 kV Line to Line	Mains power quality should be that of a typical commercial or hospital environment.
Voltage dips, short interruptions and voltage variations on power supply input lines IEC 61000-4-11	0 % UT for 0,5 cycle at 0°, 45°, 90°, 135°, 180°, 225°, 270°, & 315°  0% UT; 1 cycle at 0°C  70 % UT for 25/30 at 0°  0% UT; 250/300  Tested at 100 V, 60 Hz and 230 V, 50 Hz	0 % UT for 0,5 cycle at 0°, 45°, 90°, 135°, 180°, 225°, 270°, & 315°  0% UT; 1 cycle at 0°C  70 % UT for 25/30 at 0°  0% UT; 250/300  Tested at 100 V, 60 Hz and 230 V, 50 Hz	Mains power quality should be that of a typical commercial or hospital environment. If the user of the [Equipment or System] requires continued operation during power mains interruptions, it is recommended that the [Equipment or System] be powered from an uninterruptible power supply or battery.
Power frequency (50/60 Hz) magnetic field IEC 61000-4-8	30 A/m	30 A/m	Power frequency magnetic fields should be at levels characteristic of a typical location in a typical commercial or hospital environment

**NOTE**  $U_T$  is the a.c. mains voltage prior to application of the test level.

## Guidance and manufacturer's declaration – electromagnetic immunity

The mobile lift is intended for use in the electromagnetic environment specified below. The customer or the user of the mobile lift should assure that it is used in such an environment.  
 "Essential performance according to the manufacturer: The hoist shall not move unintentionally while being submitted to disturbances."

Immunity test	IEC 60601 test level	Compliance level	Electromagnetic environment - guidance
Conducted RF IEC 61000-4-6  Radiated RF IEC 61000-4-3	6 Vrms 150 kHz to 80 MHz  10 V/m 80MHz to 2,7GHz	6 Vrms  10 V/m	Portable and mobile RF communications equipment should be used no closer to any part of the mobile lift, including cables, than the recommended separation distance calculated from the equation applicable to the frequency of the transmitter.  <b>Recommended separation distance</b> $d = 1,2\sqrt{P}$  $d = 1,2\sqrt{P}$ 80 MHz to 800 MHz $d = 0,7\sqrt{P}$ 800 MHz to 2,7 GHz  where $P$ is the maximum output power rating of the transmitter in watts (W) according to the transmitter manufacturer and $d$ is the recommended separation distance in meters (m).  Field strengths from fixed RF transmitters, as determined by an electromagnetic site survey, <sup>a</sup> should be less than the compliance level in each frequency range. <sup>b</sup>  Interference may occur in the vicinity of equipment marked with the following symbol.  

NOTE 1 At 80MHz and 800MHz, the higher frequency range applies.

NOTE 2 These guidelines may not apply in all situations. Electromagnetic propagation is affected by absorption and reflected from structures, objects and people.

<sup>a</sup> Field strengths from fixed transmitters, such as base stations for radio (cellular/cordless) telephones and land mobile radios, amateur radio, AM and FM radio broadcast and TV broadcast cannot be predicted theoretically with accuracy. To assess the electromagnetic environment due to fixed RF transmitters, an electromagnetic site survey should be considered. If the measured field strength in the location in which the mobile lift is used exceeds the applicable RF compliance level above, the mobile lift should be observed to verify normal operation. If abnormal performance is observed, additional measures may be necessary, such as reorienting or relocating the mobile lift.

<sup>b</sup> Over the frequency range 150 kHz to 80 MHz, field strengths should be less than 10 V/m.

## Recommended separation distances between portable and mobile RF communications equipment and the mobile lift

The mobile lift is intended for use in an electromagnetic environment in which radiated RF disturbances are controlled. The customer or the user of the mobile lift can help prevent electromagnetic interference by maintaining a minimum distance between portable and mobile RF communications equipment (transmitters) and the mobile lift as recommended below, according to the maximum output power of the communications equipment.

Rated maximum output power of transmitter W	Separation distance according to frequency of transmitter m		
	150 kHz to 80 MHz $d = 1,2\sqrt{P}$	80 MHz to 800 MHz $d = 1,2\sqrt{P}$	800 MHz to 2.7 GHz $d = 0,7\sqrt{P}$
0.01	0.12	0.12	0.24
0.1	0.38	0.38	0.73
1	1.2	1.2	2.3
10	3.8	3.8	7.3
100	12	12	23

For transmitters rated at a maximum output power not listed above, the recommended separation distance  $d$  in meters (m) can be estimated using the equation applicable to the frequency of the transmitter, where  $P$  is the maximum output power rating of the transmitter in watts (W) according to the transmitter manufacturer.

**Note 1:** At 80 MHz and 800 MHz, the separation distance for the higher frequency range applies.

**Note 2:** These guidelines may not apply in all situations. Electromagnetic propagation is affected by absorption and reflection from structures, objects and people.

## Assembly

Remove the two transport safety straps, on the sling bar and on the lift mast.

### Before assembly, make sure you have the following parts:

- lift mast with lift arm and sling bar with latches, lift motor (incl. actuator);
- handle
- base with electric (M230) or manual (M220) adjustment;
- control box, charger cable, hand control with cable;
- instruction for use and quick reference guide with chain;
- 4 screw M10x25,
- 1 screw M5,
- 2 screw M10x16,
- 1 casing (M10),
- 1 Allen wrench 3 mm,
- 2 Allen wrench 6 mm.



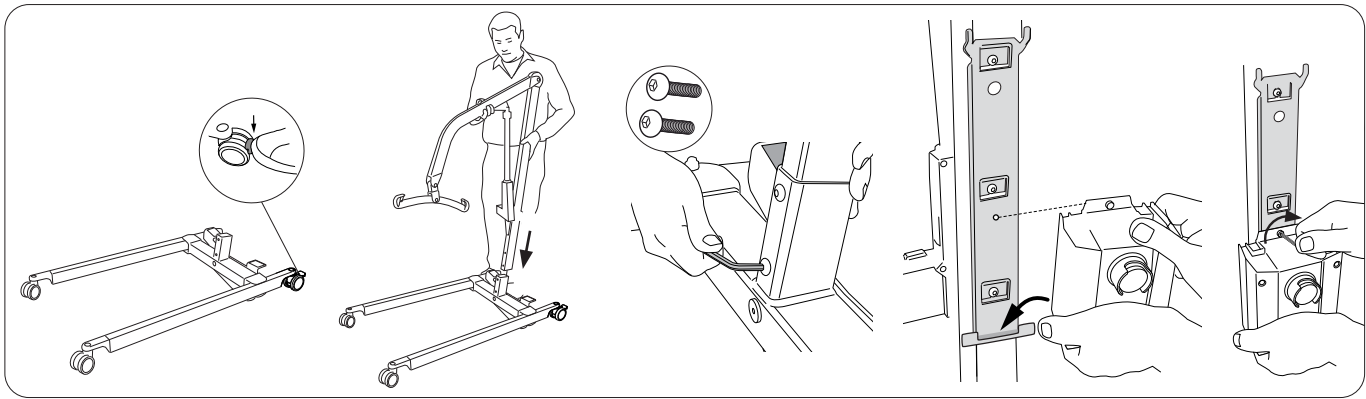

1. Place the base on floor with wheels contacting the floor. Lock both rear wheels. Place the lift mast in the foot of the base.

2. Secure the lift mast, using two of the M10x25 screws and the 6 mm Allen wrench provided. Make sure screws are tight.

3. Place the control box in the bracket on the lift mast. Lock the control box in place using the M5 screw and Allen key 3 mm provided. Do not over tighten the screw.

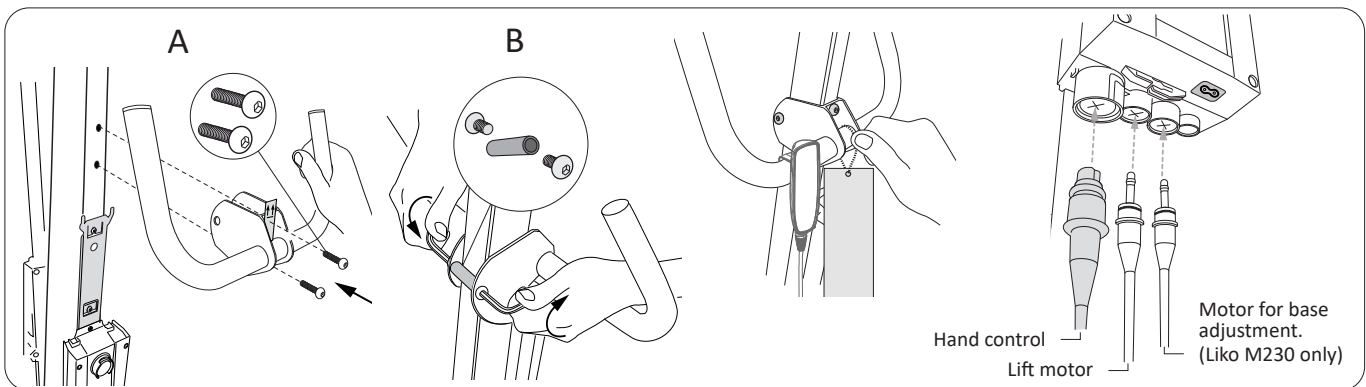

4. Install handles at the lift mast:  
 A: attach in the lift mast with two M10x25 screws and the 6 mm Allen wrench provided. (Remove decal)  
 B: insert the casing (M10) in the forward attachment of the handles, use two M10x16 and the two 6 mm Allen wrenches provided  
 Make sure the handles all four screws are tight!

5. Place the quick reference guide (use the provided chain) and the hand control on the handles.

6. Connect cables to the control box, see illustration. Make sure plugs are fully seated.

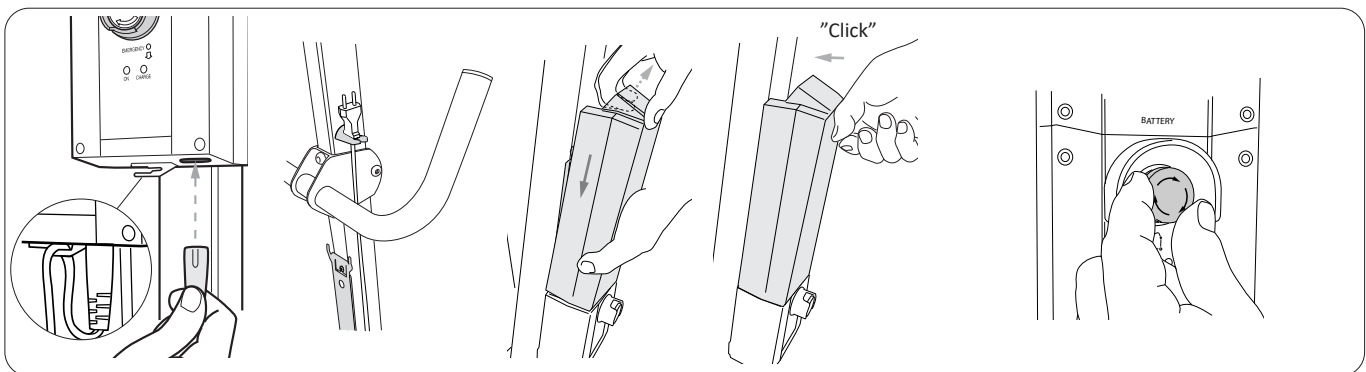

7. Connect the charger cable to the socket under the control box. Make sure the plug are fully seated. Attach the cable, see illustration.

8. Connect the battery and secure it to the control box bracket. A click sound can be heard when the battery is installed correctly.

9. Reset the emergency stop by turning the button clockwise. Charge the battery, see "**Charging the Battery**" at page 13.

**After assembly and charging, ensure that:**

- the battery has been fully charged
- lift arm motions correspond with the buttons on the handcontrol
- the adjustment of the base width is functional;
- emergency lowering works properly (mechanical and electrical)
- Rear wheel brakes, functions properly.

## Operation

**⚠** Portable RF communications equipment (including peripherals such as antenna cables and external antennas) should be used no closer than 30 cm (12 inches) to any part of the lift, including cables specified by the manufacturer. Otherwise, degradation of the performance of this equipment could result.

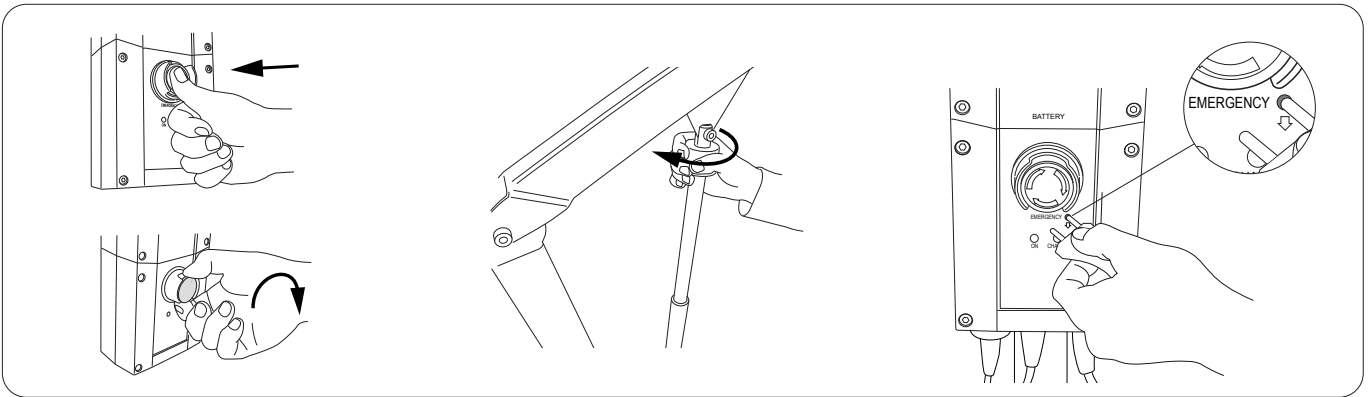

### To activate the emergency stop:

Push the red Emergency Stop button on the control box.

### To reset the emergency stop:

Turn the button clockwise.

### Mechanical Emergency Lowering

Turn the emergency lowering control clockwise, repeat the movements until the patient being lifted is on a firm surface and the strap loops of the sling can be unhooked.

### Electrical Emergency Lowering

Push a narrow object into the hole marked on the control box (marked Emergency).

**⚠** The object used to press must not be sharp, since this may cause damage to the control box!

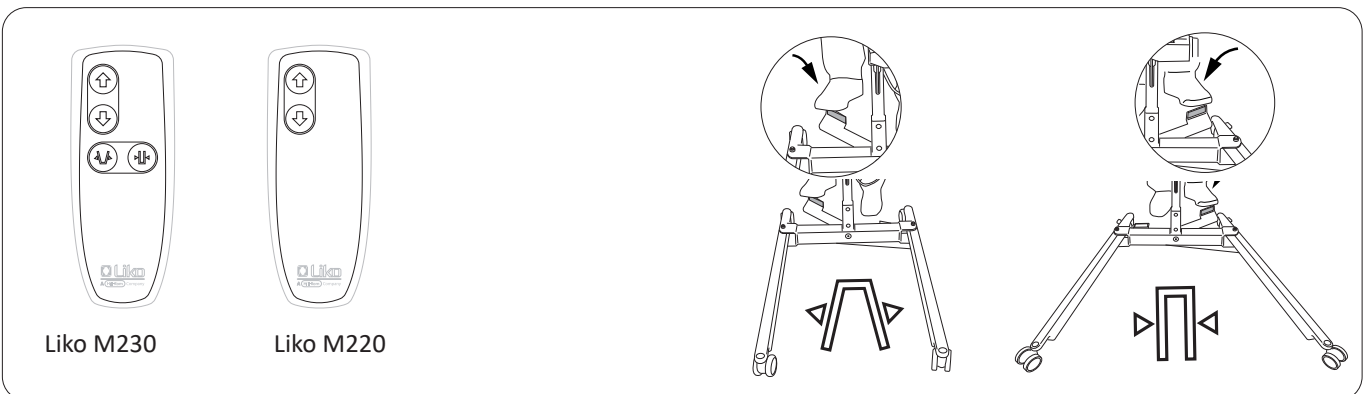

Liko M230

Liko M220

### Hand control

The lifting motion is operated with the push buttons on the hand control. The direction of the arrows applies when the hand control is held as shown in the picture. To raise or lower the lift arm, press or .

The lifting motion stops when the push button is released.

For electrical adjustment of the base width (Liko M230), push or .

### Manual Adjustment of the Base (Liko M220)

Press the raised pedal to adjust the base width.

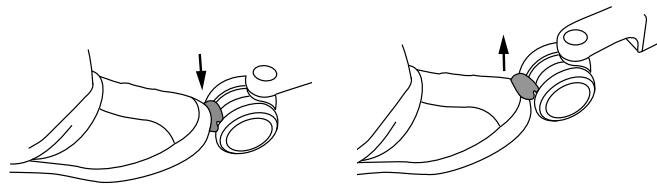

**⚠ Never move the lift by pulling on the actuator!**

**Locking the Wheels**

The rear wheels can be locked to prevent rotating and turning. The locking/unlocking of the wheels is done with the foot.

**NOTE:** When lifting, the wheels should be unlocked so that the lift can be moved to the patient's centre of gravity. The wheels should be locked, however, if there is a risk of the lift rolling into the patient, for instance, when lifting from the floor.

**⚠ Locked wheels during lifting can increase the risk of tipping.**

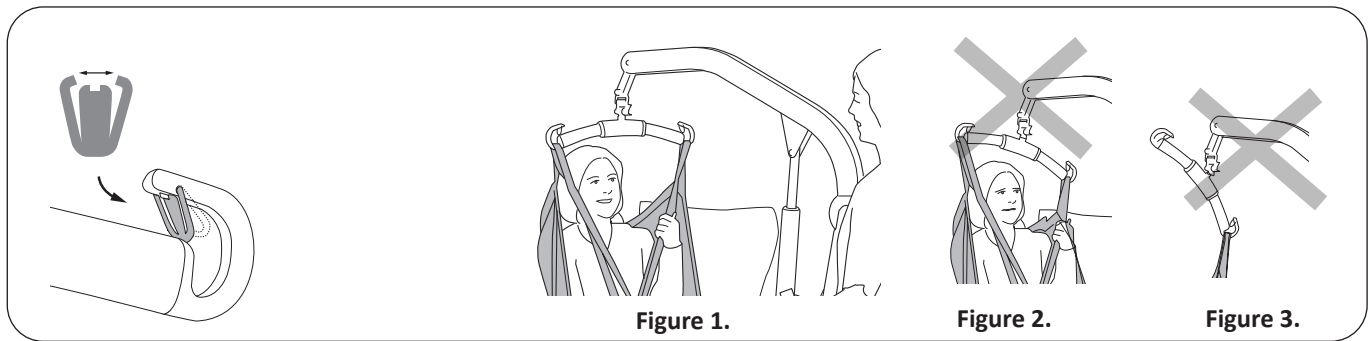

Figure 1.

Figure 2.

Figure 3.

**Installation of Latches**

After installation, ensure that the spring loaded latches is taut against the sling bar and moves freely in the sling bar hook.

**Lift correctly!**

Before each lift, make sure that:

- the Sling loops at opposite sides of the Sling are at the same height
- all the Sling loops are fastened securely in to the Slingbar hooks
- the Slingbar is level during the lift, see Figure 1.

**⚠ If Slingbar is not level (see Figure 2) or if the sling loops is wrongly attached to the slingbar (see Figure 3) lower the user to a firm surface and adjust according to the Instruction for use of Sling in use.**

**⚠ An improper lift can be uncomfortable for the user and cause damage to the lift equipment! (see Figure 2 and figure 3).**

**Position of the Lift when Lifting**

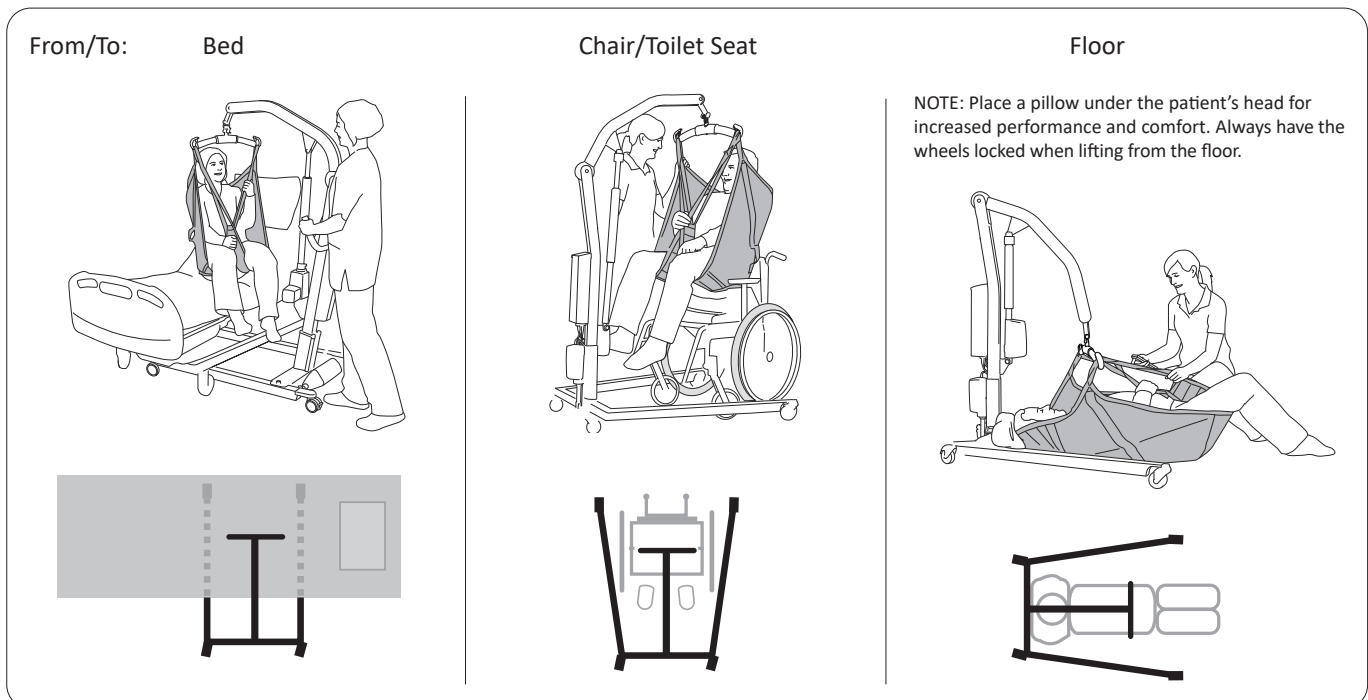

# Charging the Battery

## Indications for Charging the Battery

In the event of low battery capacity, a signal from the control box will sound. The sound will occur only when one button on the hand control is pushed in. When this happens, the battery must be charged as soon as possible. However, there is still sufficient power for additional lifts.

## Charger information

1. "ON" - lights up green when the charger is connected to mains.
2. "CHARGE" - lights up yellow constantly during charging and will turn off when charging is completed.

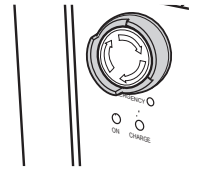
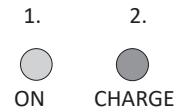

## Charging with the control box internal charger (standard)

Plug the charger cable into mains (100-240 VAC), see charger information 1 - 2 above. The battery is fully charged after about 6 hours and the charger disconnects automatically, the yellow "CHARGE" indicator turns off.

For maximum battery life, batteries must be charged regularly.

We recommend charging after each use or every night.

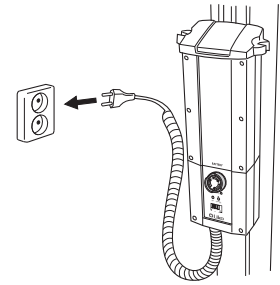

## Never charge batteries in a wet area!

## NOTE!

- If the charger cable (coiled cable) is stretched out it should be replaced to avoid the risk of the cable getting caught and torn.
- The lift cannot be used when the charger cable is plugged into a wall socket.
- If the yellow "CHARGE" diode at the control box continues to be lit after 8 hours, discontinue charging and replace the battery with a new one.
- A damaged battery shall be replaced and contact with leaking fluids shall be avoided.
- If the lift is not used every day, we recommend pushing the emergency stop after use, in order to turn off the power and conserve battery life. Make sure the battery is completely charged before pushing the emergency stop.
- The lift cannot be charged with the emergency stop activated.

## Alternative Charging Procedures

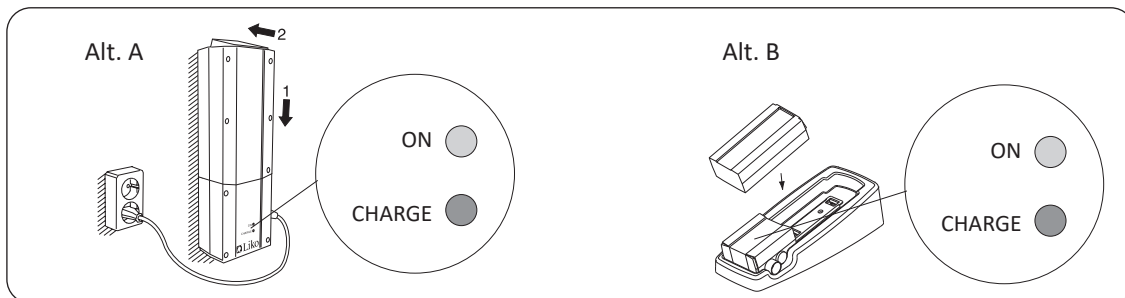

## Wall mounted charger accessory or table charger housing accessory:

Remove the battery pack from the control box by loosening the locking device on top of the battery. See chapter "Assembly".

## Charger information;

"ON" - lights up green when the charger is connected to mains.

"CHARGE" - lights up yellow constantly during charging and will turn off when charging is completed.

**Alt. A.** Place the battery pack on the wall mounted charger. Plug the charger cable into mains (100-240 VAC) check that both "ON" and "CHARGE" on the charger lights up.

**Alt. B.** Place the battery pack on the charger in the table charger housing. Plug the charger cable into mains (100-240 VAC) check that both "ON" and "CHARGE" on the charger lights up.

## Maximum Load

Different maximum loads may apply to different products on the assembled lift unit: lift, sling bar, sling and any other accessories used. For the assembled lift unit, the maximum load is always the lowest maximum load rating for any of the components. For example, a Liko M220/Liko M230 mobile lift which is approved for 182 kg (400 lbs) can be equipped with a lifting accessory which is approved for 200 kg (440 lbs). In this case, the maximum load of 182 kg (400 lbs) applies to the assembled lift unit.

Check the markings on the lift and lifting accessory or contact your Hill-Rom representative if you have any questions.

## Recommended Lifting Accessories

**⚠ Using lifting accessories other than those approved can entail a risk.**

Find generally recommended sling bars and accessories for Liko M220/Liko M230 mobile lift described below.

When changing sling bar or other lifting accessories, the highest possible lifting height of the lift is affected. Before changing lifting accessories you should always ensure that the lift, after change, can fulfil the desired lifting height in order to manage the lifting situations for which the lift is to be used.

For Liko M220 and Liko M230 mobile lift all slings compatible with Universal SlingBar 450 are recommended. For additional guidance in selecting a sling, study the operating instructions for the respective sling models. There you will also find guidance for combining Liko™ sling bars with Liko slings.

Contact your Hill-Rom representative for advice and information on Liko's product range.

### SlingBar Cover Paddy 30

Prod. No. 3607001

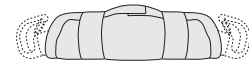

### Quick Reference Guide Liko M220/M230 with chain.

Prod. No. 2050100EN



### Holder for Quick Reference Guide

Prod. No. 2000100



### Leg Protector

Prod. No. 20190029

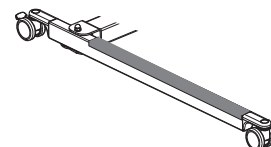

**Battery Charger**  
for wallmounting or to use with the Table charger housing

Prod. No. 2004106

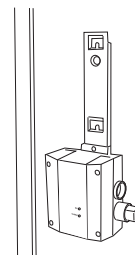

**Table Charger Housing**  
excl. charger and battery.

Prod. No. 2107103

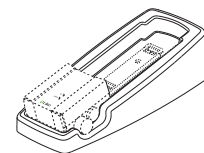

**Battery**  
Lead battery (Pb)

Prod. No. 2006106

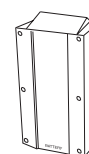

## Optional Components for Use with Lift

**LikoScale™ device**  
for weighing a patient in combination with Liko M220, M230 mobile lifts.

LikoScale™ 350, Max 400 kg (880 lbs.)

Prod. No. 3156228

*LikoScale™ devices only for use in France:*

*LikoScale™ 350, Max 400 kg (880 lbs.)*

*Prod. No. 3156228FR*

LikoScale™ 350 is certified according to the European Directive  
NAWI 2014/31/EU (Non-Automatic Weighing Instruments).

*LikoScale™ devices only for use in the United states and Canada:*

*LikoScale™ 200, Max. 200 kg (440 lbs.)*

*Prod. No. 3156225*

*LikoScale™ 400, Max. 400 kg (880 lbs.)*

*Prod. No. 3156226*

*Contact your Hill-Rom representative for more information.*

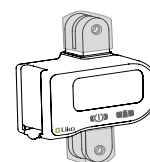

**Adapter Kit LikoScale Liko M220/M230**

Prod. No. 3156233

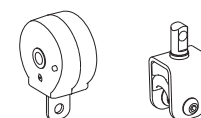

## Troubleshooting

**The lift do not work up/down with Hand Control.**

**The base-width adjustment doesn't work (in/out) with the Hand Control (Liko M230 mobile lift only).**



1. Make sure that the emergency stop button has not been activated (shall not be pressed in).
2. Check the battery capacity.
3. Make sure that the battery is properly seated in the control box.
4. Check that the charger cable is not connected to an electric outlet.
5. Check that the handcontrol cable is correctly connected to the control box.
6. Check that the lift arm actuator cable is correctly connected to the control box.
7. Check that the base width actuator cable is correctly connected to the control box.
8. *If the problem persists, please contact Hill-Rom.*

**The charger doesn't work.**



1. Make sure that the emergency stop button has not been activated (shall not be pressed in).
2. Check that the charger cables are connected correctly.
3. Make sure that the battery is properly seated in the control box.
4. Try an alternative mains outlet.
5. *If the problem persists, please contact Hill-Rom.*

**The lift is stuck in the high position.**



1. Make sure that the emergency stop button has not been activated (shall not be pressed in).
2. Make sure that the battery is properly seated in the control box.
3. Check the battery capacity.
4. Check that the handcontrol cable is connected correctly.
5. Electrical emergency lowering, use the operation panel to lower the patient onto a firm surface, see chapter; Operation.
6. Use the mechanical emergency lowering device to lower the patient onto a firm surface, see chapter; Operation.
7. *If the problem persists, please contact Hill-Rom.*

**If you hear unusual sound from the lift.**



Contact Hill-Rom.

## Recycling Instructions



Lead battery (Pb)



Waste of Electrical and Electronic Equipment (WEEE).



Metals

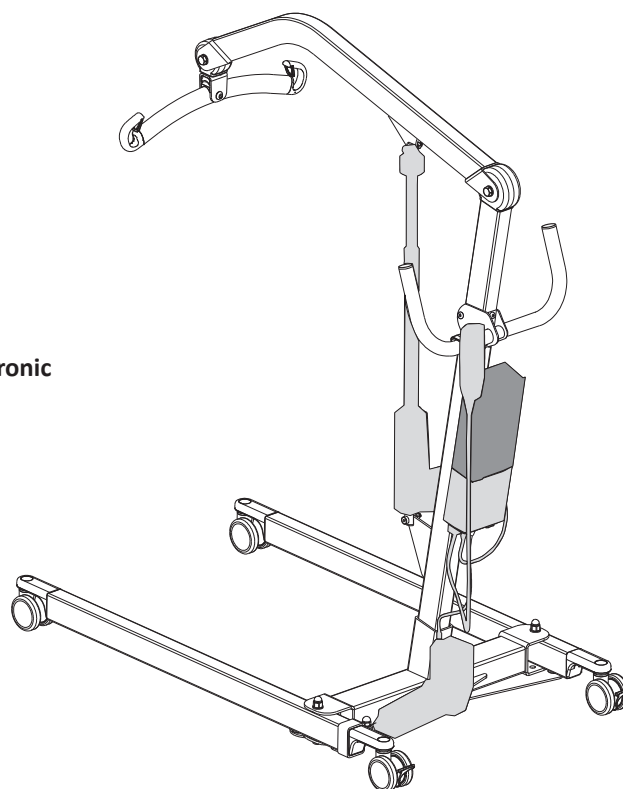

Old batteries are to be deposited at the nearest recycling station or given to personnel authorized by Hill-Rom. Liko™ M220 / Liko M230 mobile lift comply with the Directive 2012/19/EEC on waste electrical and electronic equipment.

Hill-Rom evaluates and provides guidance to its users on the safe handling and disposal of its devices to aid in the prevention of injury, including, but not limited to: cuts, punctures of the skin, abrasions, and any required cleaning and disinfection of the medical device after use and prior to its disposal. Customers should adhere to all federal, state, regional, and/or local laws and regulations as it pertains to the safe disposal of medical devices and accessories.

If in doubt, the user of the device shall first contact Hill-Rom Technical Support for guidance on safe disposal protocols.

# Cleaning and Disinfection

## Safety recommendations

Cleaning and disinfecting procedures for Liko™ Mobile lifts. This instructions do not replace the facility's own cleaning and disinfection policies.

- Wear protective equipment according to manufacturer's instruction and per facility protocol throughout the cleaning operations, such as: gloves, eye protection, apron, face mask and shoe covers.
- Unplug mains (AC power source) before cleaning and disinfection.
- Never clean the lift by pouring water on it, steam cleaning it, or by using a high-pressure jet.
- Refer to the recommendations made by the cleaning and disinfecting product manufacturer.

## Equipment:

- Protective equipment (such as: gloves, eye protection, apron, face mask and shoe covers) as recommended by the facility protocol and manufacturers instructions
- Clean buckets
- Cloths for washing and drying
- Soft brush
- Warm water
- To find Cleaning / Disinfectants compatible or not compatible for use on Liko's products, follow the "Application of commonly used Cleaning / Disinfectants on Liko products" in this document.

## Cleaning instructions

1. ⚠️ **Unplug mains (AC power source) before cleaning and disinfection.**
2. Clean the lift with a cloth moistened with warm water and a neutral cleaning agent approved by your organization. A soft brush may be used to remove stains and resistant dirt.
3. Wipe off the entire lift with a cloth moistened with clean water starting from the top and working down. The cloth shall not be so damp that it drips. To have access to all areas run the lift into the highest and lowest positions and extend the base width adjustment entirely in and out. Remove the Battery to have access behind the battery.

**NOTE! Do not clean the piston rod!**

4. Pay special attention to the following areas:
  - Sling bar
  - Mechanical emergency lowering
  - Handles
  - Control box
  - Battery
  - Hand control
  - Emergency stop
  - Pedal for base width adjustment (where applicable)
  - Wheels

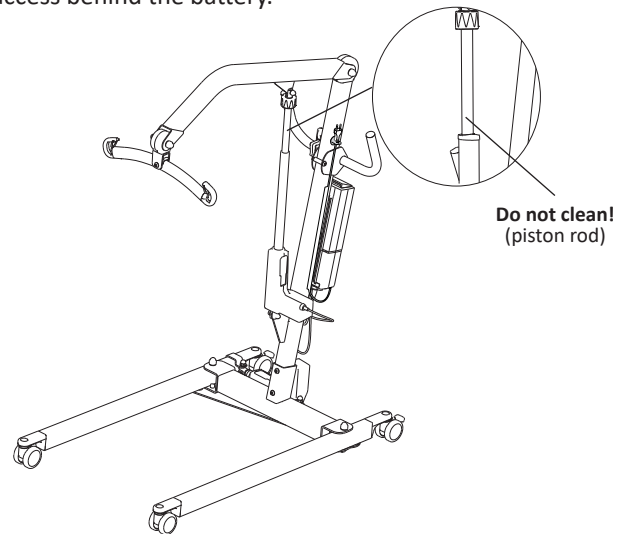

## Disinfection Instructions

1. For the use of suitable disinfectants see "Application of commonly used Cleaning / Disinfectants on Liko products" in this document.
2. Use the choice of disinfectant according to the manufacturer's instructions and repeat the work step as in "Cleaning instructions"
3. Remove traces of disinfectant after disinfection. Wipe off the lift with a cloth moistened with clean water starting from the top and working down. The cloth shall not be so damp that it drips.

- ⚠️ **The lift may not be cleaned with CSI or equivalent.**
- ⚠️ **The hand control may not be cleaned with Viraguard or equivalent.**
- ⚠️ **The control box may not be cleaned with Anioxy Spray or equivalent.**

## Application of commonly used Cleaning / Disinfectants on Liko products

Chemical class	Active ingredient	pH	Cleaners / Disinfectant *)	Manufacturer *)	May not be used on the following items:
Quaternary ammonium chloride	Didecyl dimethyl ammonium chloride = 8.704% Alkyl dimethyl benzyl ammonium chloride = 8.19%	9.0 – 10.0 in use	Virex II (256)	Johnson/Diversey	Foot rest for Sabina™ and Roll-On™
Quaternary ammonium chloride	Alkyl dimethyl benzyl ammonium chloride = 13.238% Alkyl dimethyl ethylbenzyl ammonium chloride = 13.238%	9.5 in use	HB Quat 25L	3M	
Accelerated Hydrogen Peroxide	Hydrogen Peroxide 0.1 -1.5% BenzylAlcohol: 1-5% Hydrogen Peroxide 0.1 -1.5% BenzylAlcohol: 1-5%	3	Oxivir Tb	Johnson/Diversey	The lift straps for Golvo™ and ceiling lifts
Phenolic	Ortho-Phenylphenol = 3.40% Ortho-Benzyl-para-Chlorophenol = 3.03	3.1 +/- 0.4 in use	Wexcide	Wexford Labs	
Bleach	Sodium hypochlorite	12.2	Dispatch	Caltech	The lift straps for Golvo™ and ceiling lifts
Alcohol	Isopropyl alcohol = 70%	5.0 – 7.0	Viraguard	Veridien	Hand controls for all lifts
Quaternary ammonium	n-Alkyl dimethyl benzyl ammonium chlorides = 0.105% n-Alkyl dimethyl ethylbenzyl ammonium chlorides = 0.105%	11.5 - 12.5	CSI	Central Solutions Inc.	Viking™, Liko M220™, Liko M230™, Uno™, Sabina™, Golvo™, LikoLight™, Roll-On™, LikoLight™, Multirall™
Benzyl-C12-18-alkyldimethylammonium, chlorides	Benzyl-C12-18-alkyldimethylammonium, chlorides (22 %) 2-Phenoxyethanol (20 %) Tridecylpolyethylenglycolether (15 %) Propan-2-ol (8 %)	approx 8.6 in use	Terralin Protect	Shülke	Foot rest for Sabina™ and Roll-On™
Organic peroxide (type E, solid)	Magnesium monoperoxyphthalate hexahydrate (50-100%) Anionic surfactant (5-10%) Nonionic surfactant (1-5%)	5.3 in use	Dismozon Pur	Bode	The lift straps for Golvo™ and ceiling lifts
Ethanol	Hydrogen peroxide (2.5-10 %) Lauryldimethylamine oxid (0-2.5 %) Ethanol (2.5-10 %)	7	Anioxy-Spray WS	Anios	Control box for all mobile lifts
Trosclosene sodium	Adipic acid 10-30% Amorphous silica < 1% Sodium Toluene sulphonate 5-10 % Trosclosene sodium 10-30 %	4-6 in use	Chlor-Clean	Guest Medical Ltd	The lift straps for Golvo™ and ceiling lifts

\*) Or equivalent

# Inspection and Maintenance

For trouble-free use, certain details should be checked each day the lift is used:

- Inspect the lift and check to make sure that there is no external damage.
- Check the functionality of the latches.
- Check the integrity of the lifting motion and the base-width adjustment.
- Check to make sure that the emergency lowering (both electrical and manual) works.
- Charge the batteries each day the lift is used and then check that the charger works.

Please contact your Hill-Rom representative in the event of any uncertainties or questions.

When necessary, clean the lift with a moist cloth and check that the wheels are free from dirt. Find more detailed information regarding cleaning and disinfection of your Liko product in chapter; *Cleaning and Disinfection*.

**⚠ The lift should not be exposed to running water.**

## Service

A periodic inspection of the lift should be carried out at least once per year.

**⚠ Periodic inspection, repair and maintenance should be performed only in accordance with the Liko™ Service Manual, and by personnel authorized by Hill-Rom and using original Liko™ spare parts.**

**⚠ Service activities are not allowed with the patient in the lift.**

## Service Agreement

Hill-Rom offers the opportunity to enter into service contracts for the maintenance and regular inspection of your Liko product.

## Expected Life Time

The product has an expected service life of 10 years when correctly handled, serviced and periodically inspected in accordance with Liko's instructions.

Parts listed below are subject to wear and tear and have specific expected life time:

- Handcontrol, expected life time 2 years,
- Battery, expected life time 3 years.

## Transport and Storage

During transport, or if the lift is not to be used for a long time, the Emergency Stop should be activated.

The environment where the lift is transported and stored should have a temperature of -10°C to +50°C (14°F to 122°F), 10-95% humid., atmospheric pressure 700-1060 hPa.

## Product Changes

Liko products undergo continuous development, which is why we reserve the right to make product changes without prior notice. Contact your Hill-Rom representative for advice and information about product upgrades.

## Design and Quality by Liko in Sweden

The management system for both manufacturing and development of the product is certified in accordance with ISO9001 and its equivalent for the medical device industry, ISO13485. The management system is also certified in accordance with the environmental standard ISO14001.

## Notice to Users and/or Patients in EU

Any serious incident that has occurred in relation to the device, should be reported to the manufacturer and the competent authority of the Member State in which the user and/or patient is established.



[www.hillrom.com](http://www.hillrom.com)

Liko AB  
Nedre vägen 100  
975 92 Luleå, Sweden  
+46 (0)920 474700

Liko AB is a subsidiary of Hill-Rom Holdings Inc.

Enhancing outcomes for  
patients and their caregivers:

**Hill-Rom**